

1.25Gbps / 2.50Gbps Hybrids

InGaAs Photodetectors / Transimpedance Amplifiers

FCI-H125/250G-InGaAs-XX series are compact and integrated high speed InGaAs photodetector with wide dynamic range transimpedance amplifier. Combining the detector with the TIA in a hermetically sealed 4 pin TO-46 package provides ideal conditions for high speed signal amplification. High speed and superior sensitivity make these devices ideal for high-bit rate receivers used in LAN, MAN, WAN, and other high speed communication systems. TO packages come standard with a lensed cap to enhance coupling efficiency, or with a broadband double sided AR coated flat window. The FCI-H125/250G-InGaAs-XX series are also offered with FC, SC, ST and SMA receptacles.

APPLICATIONS

- High Speed Optical Communications
- Gigabit Ethernet
- Fibre Channel
- ATM
- SONET OC-48 / SDH STM-16

FEATURES

- InGaAs Photodetector / Low Noise Transimpedance Amplifier
- High Bandwidth / Wide Dynamic Range
- Hermetically Sealed TO-46 Can
- Single +3.3 to +5V Power Supply
- Spectral Range 1100nm to 1650nm
- Differential Output

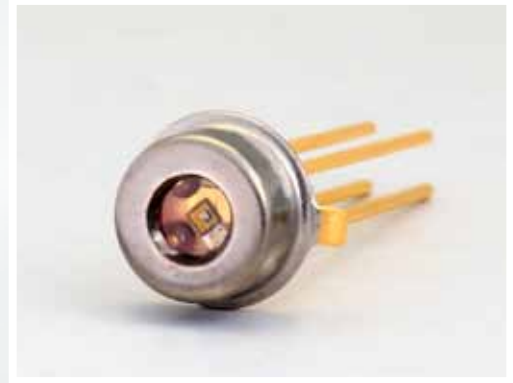

Absolute Maximum Ratings

PARAMETERS	SYMBOL	MIN	MAX	UNITS
Storage Temperature	T_{stg}	-40	+125	°C
Operating Temperature	T_{op}	-40	+85	°C
Supply Voltage	V_{cc}	0	+5.5	V
Input Optical Power	P_{IN}	---	+3	dBm

Electro-Optical Characteristics

$T_A = 23^\circ\text{C}$, $V_{cc} = +3.3\text{V}$, 1310nm, 100Ω Differential AC Load

PARAMETERS	SYMBOL	CONDITIONS	FCI-H125G-InGaAs-75			FCI-H250G-InGaAs-75			UNITS
			MIN	TYP	MAX	MIN	TYP	MAX	
Supply Voltage	V_{cc}	---	+3	---	+5.5	+3	---	+5.5	V
Supply Current	I_{cc}	* $T_A = 0$ to 70°C	---	26	*55	---	35	*65	mA
Active Area Diameter	AA_ϕ	---	---	75	---	---	75	---	μm
Operating Wavelength	λ	---	1100	---	1650	1100	---	1650	nm
Responsivity	R_λ	-17dBm, Differential	1800	2500	---	1600	2500	---	V/W
Transimpedance	---	-17dBm, Differential	---	2800	---	---	2800	---	Ω
Sensitivity	S	BER 10^{-10} , PRBS 2^7-1	-24	-28	---	-20	-24	---	dBm
Optical Overload	---	---	-3	---	---	0	---	---	dBm
Bandwidth	BW	-3dB, Small Signal	---	900	---	---	1750	---	MHz
Low Frequency Cutoff	---	-3dB	---	45	---	---	30	---	kHz
Differential Output Voltage	$V_{OUT, P-P}$	-3dBm	180	250	420	200	400	600	mV _{P-P}
Output Impedance	---	---	47	50	53	47	50	53	Ω
Transimpedance Linear Range	---	<5%	30	---	---	40	---	---	μW _{P-P}

Use AC coupling and differential 100Ω load for best high-speed performance. Devices are not intended to drive DC coupled, 50Ω grounded load.

1.25Gbps / 2.50Gbps Hybrids

InGaAs Photodetectors / Transimpedance Amplifiers

FCI-H125G-InGaAs-75

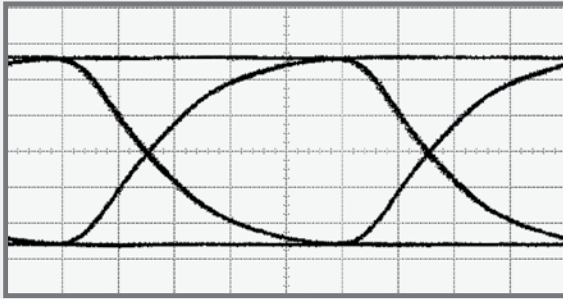

50mV / div, 160ps / div, -6dBm, 1310nm, PRBS2⁷-1, Diff.

FCI-H250G-InGaAs-75

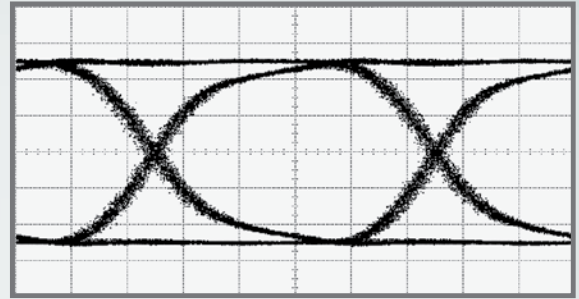

80mV / div, 80ps / div, -6dBm, 1310nm, PRBS2⁷-1, Diff.

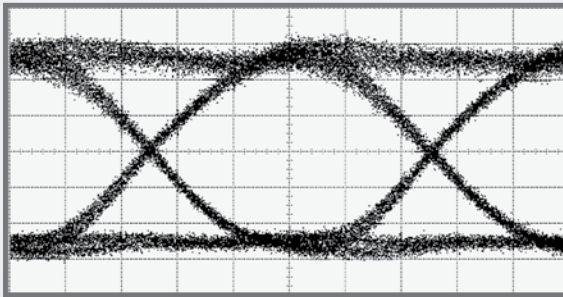

8mV / div, 160ps / div, -21dBm, 1310nm, PRBS2⁷-1, Diff.

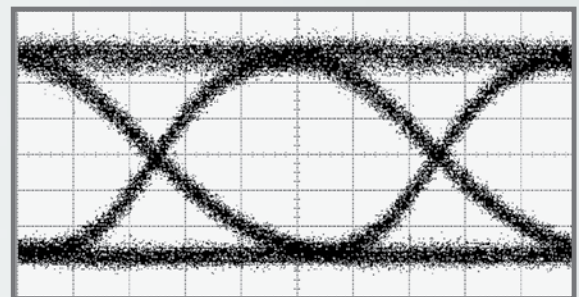

10mV / div, 80ps / div, -19dBm, 1310nm, PRBS2⁷-1, Diff.

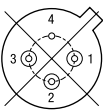
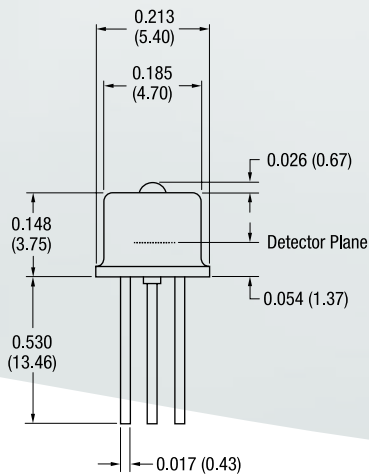

Bottom View

PINOUT

1	D _{out}
2	V _{CC}
3	D _{out}
4	GND

Pin Circle Diameter = 0.100 (2.54)

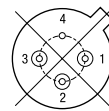
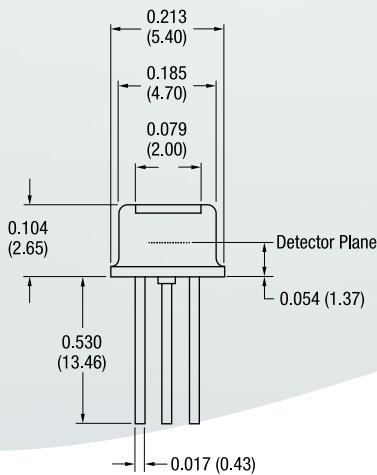

Bottom View

PINOUT

1	D _{out}
2	V _{CC}
3	D _{out}
4	GND

Pin Circle Diameter = 0.100 (2.54)

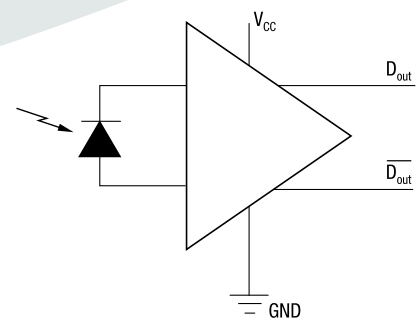

Notes:

- All units in inches (mm).
- All tolerances: 0.005 (0.125).
- Please specify when ordering the flat window or lens cap devices.
- The flat window devices have broadband AR coatings centered at 1310nm.
- The thickness of the flat window=0.008 (0.21).